

PRODUCT INFORMATION PACKET

marathon[®]
Motors

Model No: 365TTGS4046

Catalog No: U094

Other Purpose Motor, 75 & 60 HP, 3 Ph, 60 & 50 Hz, 230/460 & 190/380 V, 1800 & 1500 RPM,
365T Frame, EPFC

Regal and Marathon are trademarks of Regal Rexnord Corporation or one of its affiliated companies.

©2023 Regal Rexnord Corporation, All Rights Reserved. MC017097E

RegalRexnord

Nameplate Specifications

Phase	3	Output HP	75 & 60 Hp
Output KW	56.0 & 45.0 kW	Voltage	230/460 & 190/380 V
Speed	1780 & 1480 rpm	Service Factor	1.15 & 1.15
Frame	365T	Enclosure	Explosion Proof Fan cooled
Thermal Protection	No Protection	Efficiency	94.1 & 94.1 %
Ambient Temperature	40 °C	Frequency	60 & 50 Hz
Current	178/89 & 172/86 A	Power Factor	84
Duty	Continuous	Insulation Class	F
Design Code	B	KVA Code	G
Drive End Bearing Size	6314	Opp Drive End Bearing Size	6312
UL	Listed	CSA	Y
CE	N	IP Code	54
Number of Speeds	1		

Technical Specifications

Electrical Type	Squirrel Cage Inverter Rated	Starting Method	Line Or Inverter
Poles	4	Rotation	Reversible
Resistance Main	.073 Ohms	Mounting	Rigid Base
Motor Orientation	Horizontal	Drive End Bearing	Ball
Opp Drive End Bearing	Ball	Frame Material	Cast Iron
Shaft Type	T	Overall Length	32.74 in
Frame Length	14.50 in	Shaft Diameter	2.375 in
Shaft Extension	6.12 in	Assembly/Box Mounting	F1 ONLY
Connection Drawing	A-EE7308AD	Outline Drawing	B-SS518459-1450

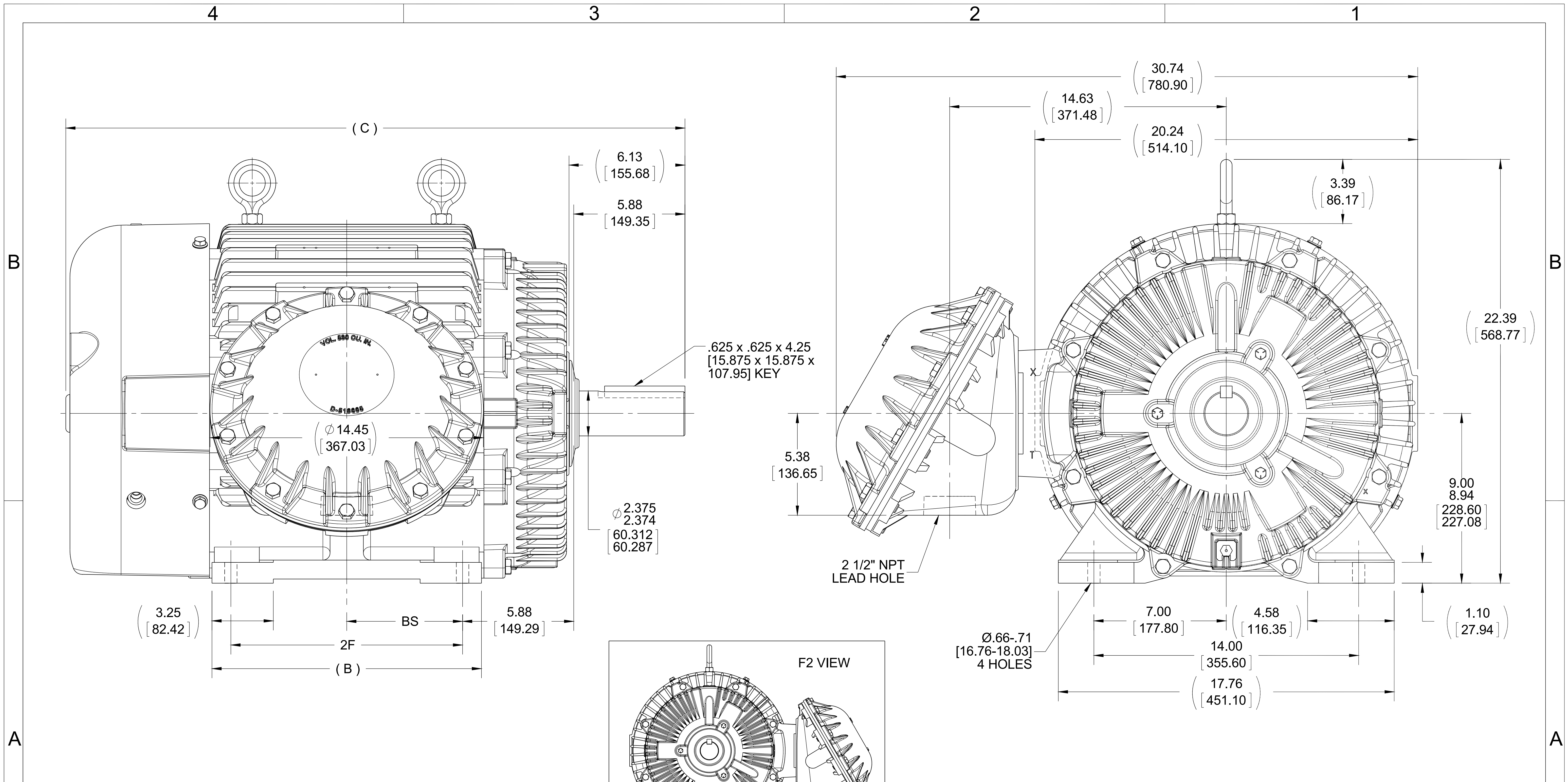

- NOTES:
 1. CONDUIT BOX CAN BE ROTATED IN 90° STEPS.
 2. CONDUIT BOX CAN BE MOUNTED ON OPPOSITE SIDE BY REMOVING BRACKETS AND TURNING FRAME 180°.
 3. NAMEPLATES TO BE READ FROM CONDUIT BOX SIDE OF MOTOR.

DASH	FRAME	B	C	2F	BS
1350	364T	13.25 [336.55]	31.74 [806.20]	11.25 [285.75]	5.62 [142.75]
1450	365T	14.25 [361.95]	32.74 [831.60]	12.25 [311.15]	6.12 [155.45]

DRAWING REVISION G	REVISION BY TDB	DATE 07-28-2015
ECO ECO-0082089	APPROVED BY DJK	DATE 07-30-2015
ECO DESCRIPTION UPDATED TO CURRENT STD'S		
<small>COPYRIGHT REGAL BELOIT AMERICA, INC. ALL RIGHTS RESERVED. PROPRIETARY AND CONFIDENTIAL INFORMATION - THIS DOCUMENT IS THE PROPERTY OF REGAL BELOIT AMERICA, INC. ("OWNER") AND CONTAINS OWNER'S PROPRIETARY INFORMATION. ANY PERSON, CORPORATION OR OTHER FIRM RECEIVING IT IS DEEMED, BY RECEIVING IT, TO AGREE THAT IT, AND/OR ANY PART OF IT, SHALL NOT BE DISCLOSED TO ANY PERSON, CORPORATION OR OTHER ENTITY, DUPLICATED, AND/OR USED, EXCEPT AS EXPRESSLY APPROVED IN WRITING IN ADVANCE BY OWNER. THIS DOCUMENT SHALL BE RETURNED TO OWNER UPON REQUEST. IT MAY BE SUBJECT TO CERTAIN RESTRICTIONS UNDER APPLICABLE EXPORT CONTROL LAWS AND REGULATIONS.</small>		

TOLERANCES UNLESS OTHERWISE SPECIFIED:			
DEC.	INCH	mm	ANGLE
.X	±0.1	[±2.5]	±7° 30"
.XX	±0.03	[±0.76]	
.XXX	±0.005	[±0.127]	
.XXXX	±0.0005	[±0.0127]	
REMOVE BURRS & BREAK SHARP EDGES: .003/.015 [0.076/.381] X 45°			
CORNER FILLETS: R.02 [0.51]			
MACHINED SURFACES: 200 INCH/mm 5.1			
mm SHOWN IN [BRACKETS]			

DRAWN BY TJB
DATE 05-14-2001
APPROVED BY GK
DATE 09-07-2001
REFERENCE
THIRD ANGLE PROJECTION

REGAL ™ Regal Beloit America, Inc.	
DESCRIPTION OUTLINE 360T FR. - EXP. PROOF	
MATERIAL	PROCESS/FINISH
SIZE B	DRAWING NUMBER SS518459
SHEET 1 OF 1	

LOW VOLTAGE

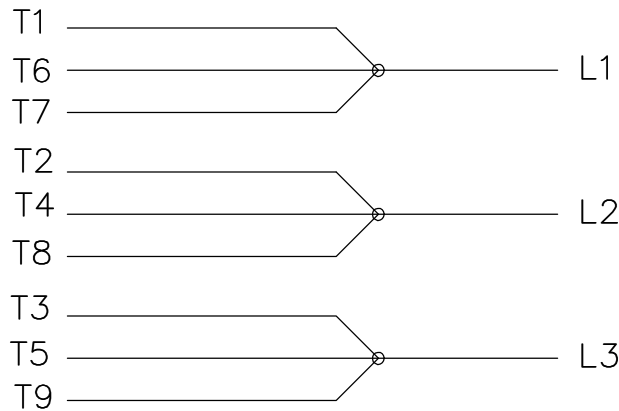

HIGH VOLTAGE

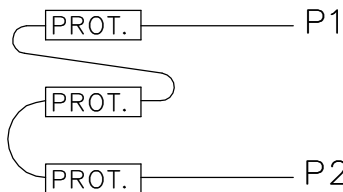
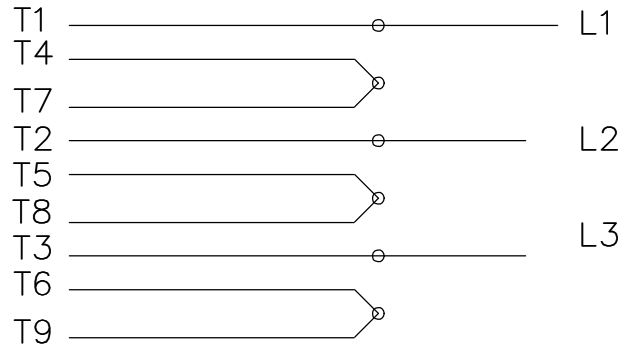

LOW VOLTAGE

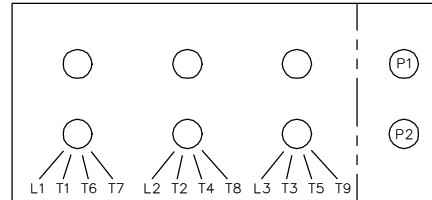

HIGH VOLTAGE

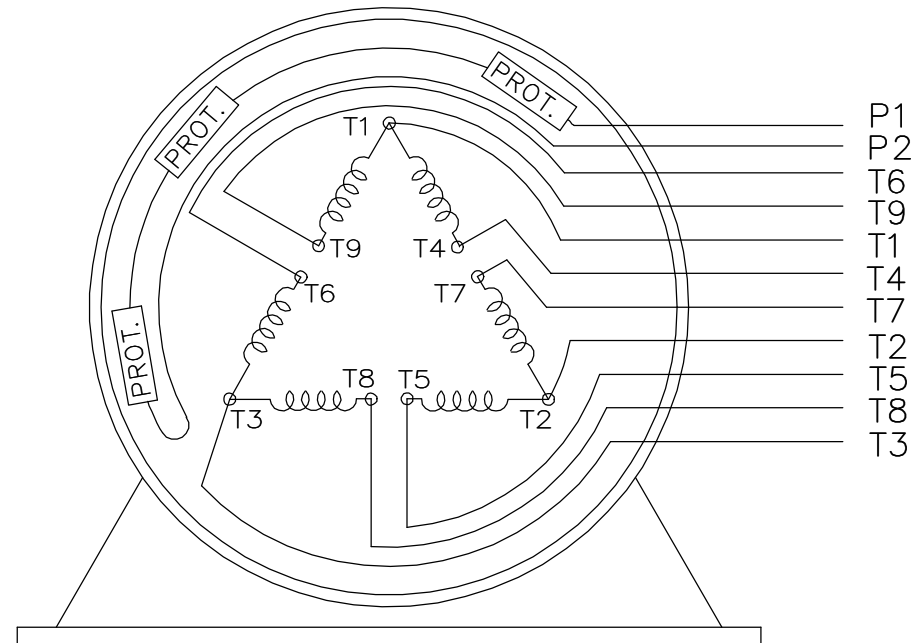
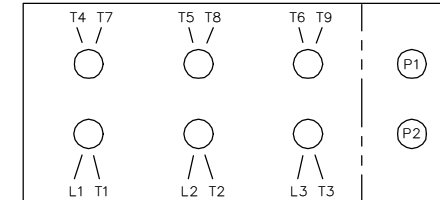

VIEW OF TERMINAL END

WHEN MORE THAN ONE PROT. IS USED; PROT. ARE CONNECTED IN SERIES

DRAWING REVISION L	REVISION BY JP	REV DATE/© DATE 06-21-2019	TOLERANCES (EXCEPT AS NOTED): DEC. INCH mm ANGLE .X ±0.1 [±3] .XX ±0.02 [±0.5] .XXX ±0.005 [±0.13] .XXXX ±0.0005 [±0.013] REMOVE BURRS & BREAK SHARP EDGES: .003/.015 [.08/.38] X 45° CORNER FILLETS: R.02 [.5] MACHINED SURFACES: 200/ 5.1 INCH/mm mm DIMENSIONS IN [BRACKETS] ARE FOR REFERENCE ONLY	DRAWN BY MJD	Regal Beloit America, Inc.	
ECO ECO-0168744	APPROVED BY MH	DATE 06-21-2019		DATE 12-19-1997		
ECO DESCRIPTION UPDATED TO CURRENT STANDARDS			DESCRIPTION CONN DIAGRAM-EXTERNAL	APPROVED BY GK	MATERIAL	PROCESS/FINISH
COPYRIGHT (PER REVISION DATE) REGAL BELOIT AMERICA, INC. ALL RIGHTS RESERVED. PROPRIETARY AND CONFIDENTIAL INFORMATION - THIS DOCUMENT IS THE PROPERTY OF REGAL BELOIT AMERICA, INC. ("OWNER") AND CONTAINS OWNER'S PROPRIETARY INFORMATION. ANY PERSON, CORPORATION OR OTHER FIRM RECEIVING IT IS DEEMED, BY RECEIVING IT, TO AGREE THAT IT, AND/OR ANY PART OF IT, SHALL NOT BE DISCLOSED TO ANY PERSON, CORPORATION OR OTHER ENTITY, DUPLICATED, AND/OR USED, EXCEPT AS EXPRESSLY APPROVED IN WRITING IN ADVANCE BY OWNER. THIS DOCUMENT SHALL BE RETURNED TO OWNER UPON REQUEST. IT MAY BE SUBJECT TO CERTAIN RESTRICTIONS UNDER APPLICABLE EXPORT CONTROL LAWS AND REGULATIONS.				DATE 01-07-1998		
			THIRD ANGLE PROJECTION	REFERENCE		